

CERTIFICATE OF APPROPRIATENESS

Applicant: Stephen Le, owner and Cory P. Decuire, agent

Property: 3215 and 3219 White Oak Drive, lots 23 & 24, block 286, Houston Heights Subdivision. The property includes 3,540 sqft of building area situated on a 8,257.65sqft square foot corner lot.

Significance: Noncontributing commercial structure, constructed circa 2002 and Noncontributing apartment building constructed c. 1950 (remodeled 2018), located in the Houston Heights Historic District South.

Proposal: New Construction – Demolish existing non-contributing buildings.

- New construction of 3,137 sq. ft. retail building.
- Associated site work, detention, and parking areas will be provided. Alleyway improvements will be made to the existing access drive to provide maneuvering clearance for the new parking areas.
- Comprised of brick veneer, stucco, and cast stone accents on primary façade/street facing elevations
- Decorative but structural steel columns on front elevation facing white oak
- Aluminum window storefront system will be recessed
- Meets Heights Design Guidelines Measurable Standards for atypical use (nonresidential).

Public Comment: No comment received.

Civic Association: No comment received.

Recommendation: Approval

HAHC Action: -

APPROVAL CRITERIA

NEW CONSTRUCTION IN A HISTORIC DISTRICT

Sec. 33-242(a): HAHC shall issue a certificate of appropriateness for new construction in a historic district upon finding that the application satisfies the following criteria:

S D NA

S - satisfies D - does not satisfy NA - not applicable

- (1) The distance from the property line of the front and side walls, porches, and exterior features of any proposed new construction must be compatible with the distance from the property line of similar elements of existing contributing structures in the context area;
- (2) The exterior features of the new construction must be compatible with the exterior features of existing contributing structures in the context area;
- (3) The scale and proportions of the new construction, including the relationship of the width and roofline, overall height, eave height, foundation height, porch height, roof shape, and roof pitch, and other dimensions to each other, must be compatible with the typical scale and proportions of existing contributing structures in the context area unless special circumstances, such as an atypical use, location, or lot size, warrant an atypical scale and proportions;
- (4) The height of the new construction must not be taller than the typical height of existing contributing structures in the context area unless special circumstances, such as an atypical use, location, or lot size, warrant an atypical height, except that;

(a) Design guidelines for an individual historic district may provide that a new construction with two stories maybe be constructed in a context area with only one-story contributing structures as long as the first story of the new construction has proportions compatible with the contributing structures in the context area, and the second story has similar proportions to the first story; and

(b) A new construction shall not be constructed with more than one story in a historic district that is comprised entirely of one-story contributing structures, except as provided for in design guidelines for an individual historic district.

HEIGHTS DESIGN GUIDELINES

- In accordance with Sec. 33-276, the proposed activity must comply with the City Council approved Design Guidelines.

HEIGHTS DESIGN GUIDELINES MEASURABLE STANDARDS

S D NA

S - satisfies D - does not satisfy NA - not applicable

Maximum Lot Coverage (Addition and New Construction)

LOT SIZE	MAXIMUM LOT COVERAGE
<4000	.44 (44%)
4000-4999	.44 (44%)
5000-5999	.42 (42%)
6000-6999	.40 (40%)
7000-7999	.38 (38%)
8000+	.38 (38%)

Existing Lot Size: 8,257.65sqft
 Proposed Lot Coverage: 3,137
 Proposed Percentage: .38 (38%)

Front Setbacks (New Construction)

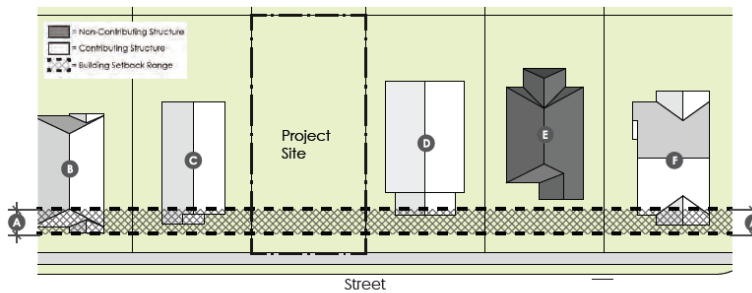

KEY	MEASUREMENT	APPLICATION
A	RANGE	Locate the front of the primary building within the range of front setbacks for contributing buildings within the context area.

Proposed front setback: 5' facing White Oak– others on white oak are 0-5' from sidewalk, Columbia street setback is 10' which is further back than homes on that block – see site plan.

Rear Setbacks (Addition and New Construction)

The City of Houston requires a minimum setback of three feet from the rear property line for all properties, except under the following circumstances:

- A front-facing garage which is located with its rear wall at the alley may have a zero-foot setback.
- An alley-loading garage generally must be located to establish a minimum of 20 feet of clearance from an opposing alley-loading garage door, the rear wall of a front-facing garage, or a fence; a 24-foot clearance is preferred.

Proposed rear setback: All setbacks 5' or more

Side Setbacks (Addition and New Construction)

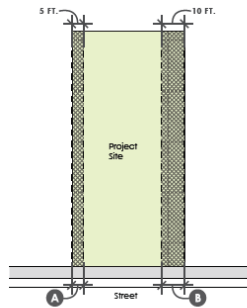

KEY	MEASUREMENT	APPLICATION
A	3 FT.	Minimum distance between side wall and the property line for lots less than 35 feet wide
	5 FT.	Minimum distance between the side wall and the property line
B	REMAINING	Difference between minimum side setback of 5 feet and minimum cumulative side setback
	6 FT.	Minimum cumulative side setback for lots less than 35 feet wide
C	10 FT.	Minimum cumulative side setback for a one-story house
	15 FT.	Minimum cumulative side setback for a two-story house

Proposed side setback (1): 5'

Proposed side setback (2): 5'

Cumulative side setback: 10' – OK for 1 story building

Maximum Floor Area Ratio (Addition and New Construction)

LOT SIZE	MAXIMUM FAR
<4000	.48
4000-4999	.48
5000-5999	.46
6000-6999	.44
7000-7999	.42
8000+	.40

Existing Lot Size: 8,257.65sqft

Proposed FAR: .38 (38%)

Side Wall Length and Insets (Addition and New Construction)

MEASUREMENT	APPLICATION
50 FT.	Maximum side wall length without inset (1-story)
40 FT.	Maximum side wall length without inset (2-story)
1 FT.	Minimum depth of inset section of side wall (1-story)
2 FT.	Minimum depth of inset section of side wall (2-story)
6 FT.	Minimum length of inset section of side wall

Side Wall Length: 37'1"

Inset Length: not applicable

S D NA S - satisfies D - does not satisfy NA - not applicable

 Eave Height (Addition and New Construction)

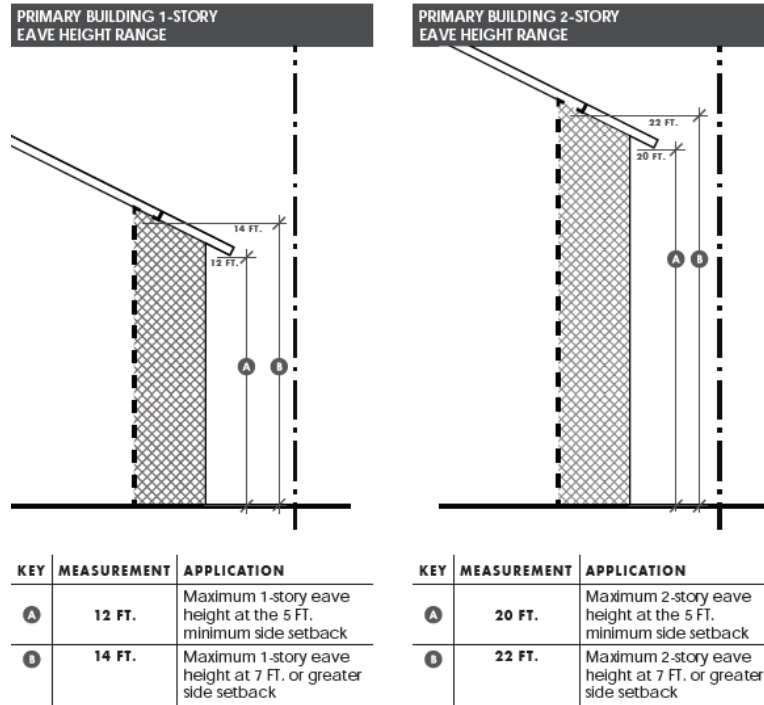

Proposed eave height: 19' – due to atypical use (nonresidential style) and comparable contributing context buildings in this “commercial style” this measurable should not be applied. Comparable are one-story, with flat roofs, sometimes with parapets and range from 14' to 28' – see contributing context worksheet.

 Building Wall (Plate) Height (Addition and New Construction)

MEASUREMENT	APPLICATION
36 IN.	Maximum finished floor height (as measured at the front of the structure)
10 FT.	Maximum first floor plate height
9 FT.	Maximum second floor plate height

Proposed finished floor: 0
 Proposed first floor plate height:
 Proposed second floor plate height:
 due to atypical use (nonresidential style) and comparable contributing context buildings in this “commercial style” this measurable should not be applied. Comparable are one-story, with flat roofs, sometimes with parapets and range from 14' to 28' – see contributing context worksheet.

-
-
-

Porch Eave Height (Addition and New Construction)

MEASUREMENT	APPLICATION
9-11 FT.	Minimum and maximum 1-story porch eave height.

Proposed porch eave height: No porch

-
-
-

Front Wall Width and Insets (New Construction)

MEASUREMENT	APPLICATION
30 FT.	Maximum front wall width before inset
4 FT.	Minimum width of inset section of front wall
40 FT.	Maximum width of 1-story building for lots <= 50 ft wide
35 FT.	Maximum width of 2-story building for lots <= 50 ft wide
50 FT.	Maximum width of building for lots > 50 ft wide

Proposed front wall width: 88' due to atypical use (nonresidential style) and comparable contributing context buildings in this "commercial style" this measurable should not be applied. Comparable are one-story buildings have similar front wall widths. See Google aerial map with figure grounds.

-
-
-

Front Porch Width and Depth (Addition and New Construction)

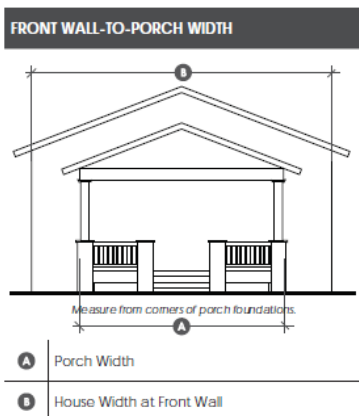

KEY	MEASUREMENT	APPLICATION
A	Porch Width	
B	House Width at Front Wall	

KEY	MEASUREMENT	APPLICATION
A	50%	Minimum percentage of front wall width that is covered by porch

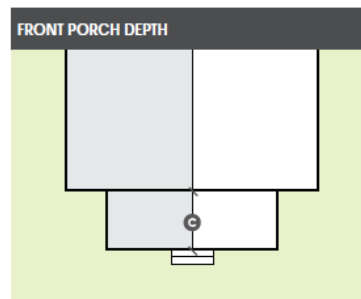

KEY	MEASUREMENT	APPLICATION
C	6 FT.	Minimum depth of front porch

Proposed front porch width: no front porch

Detached Garage Ridge Height (New Construction)

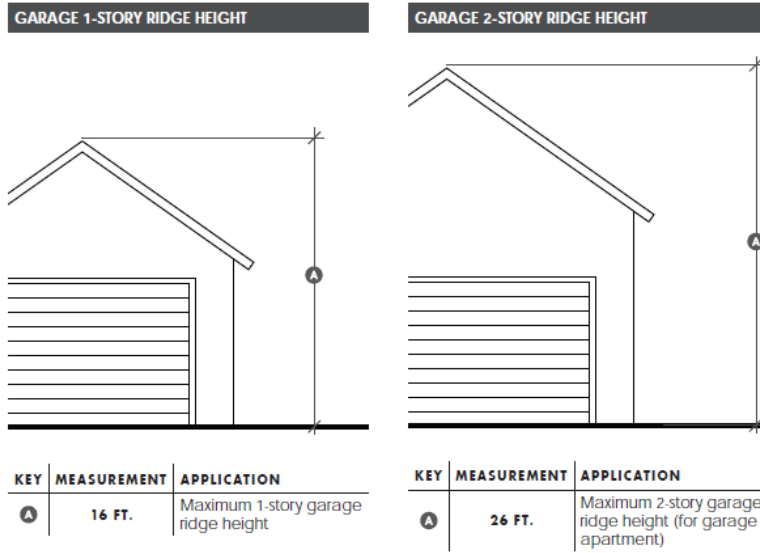

Proposed ridge height: not applicable



PROPERTY LOCATION
HOUSTON HEIGHTS SOUTH HISTORIC DISTRICT

Building Classification

- Contributing
- Non-Contributing
- Park

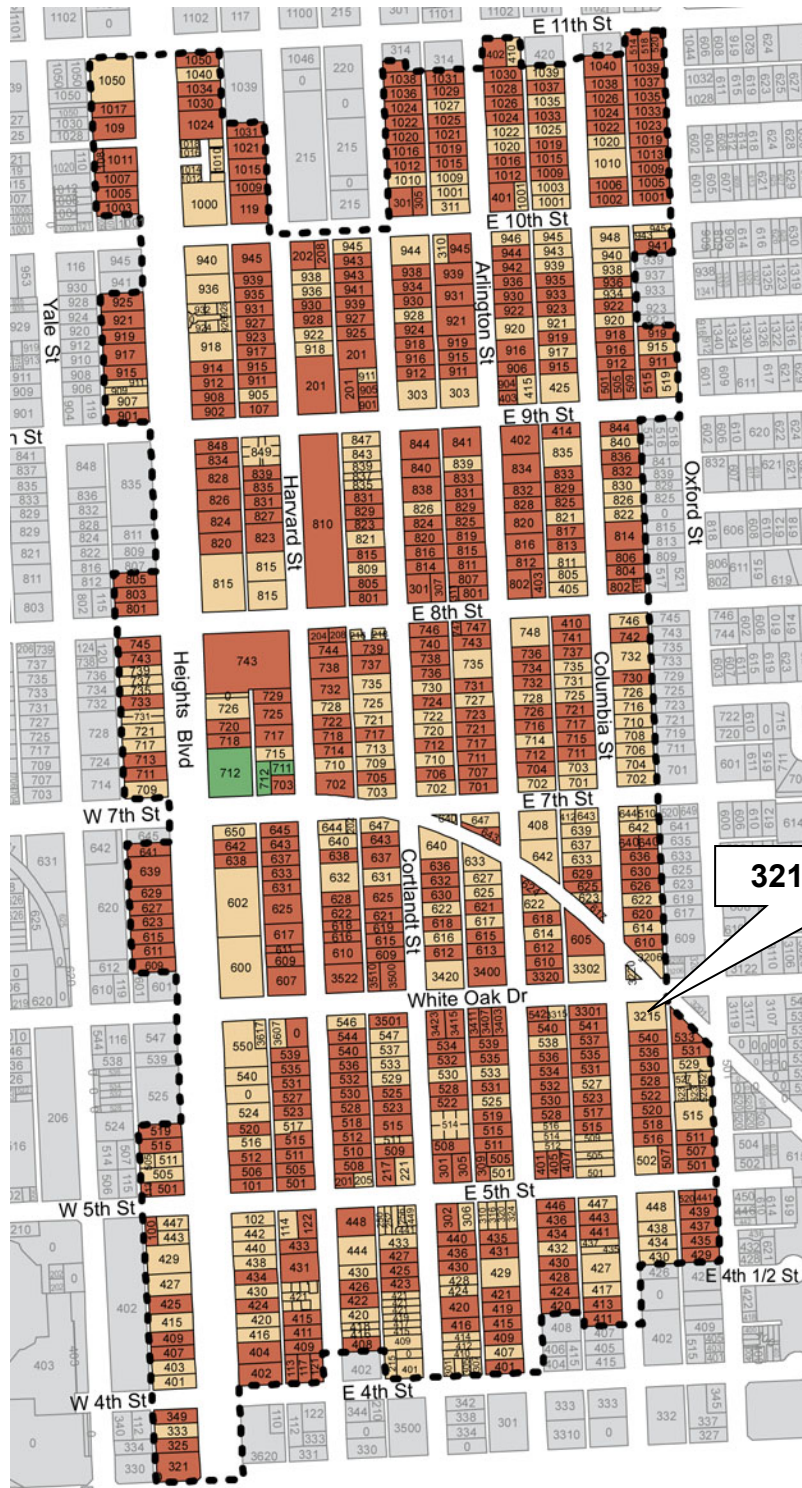

3215 White Oak

INVENTORY PHOTO



CURRENT PHOTOS

A



EXISTING CAR WASH BUILDING

B



EXISTING APARTMENT BUILDING



SITE PLAN
EXISTING

WHITE OAK DRIVE

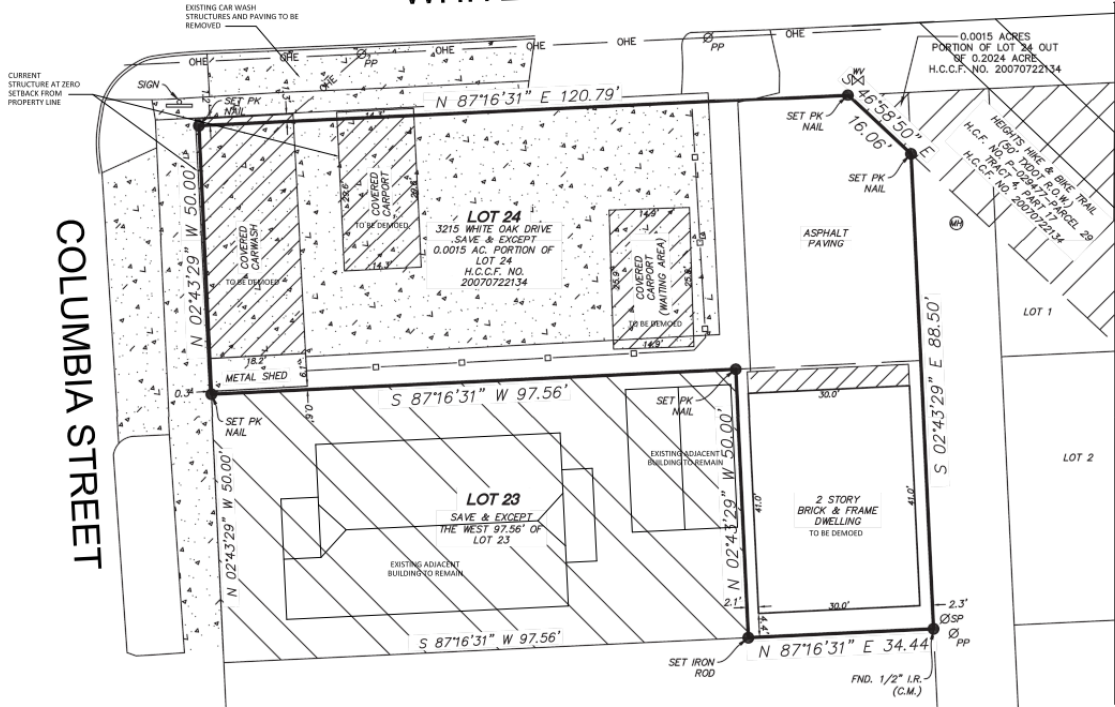

PROPOSED

WHITE OAK DRIVE

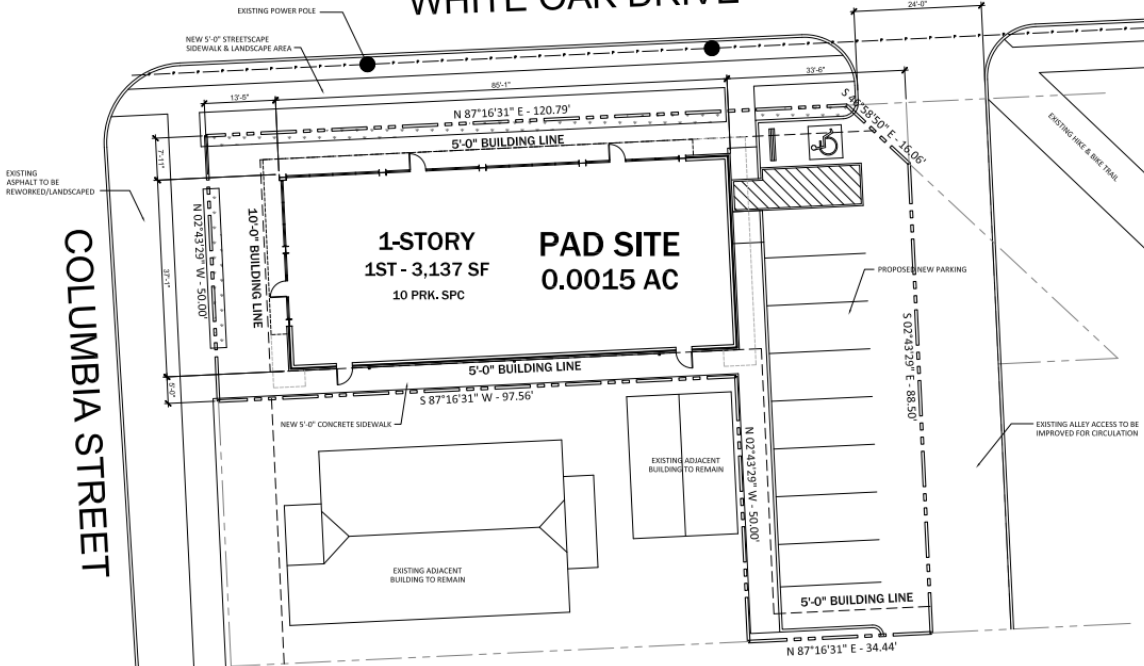

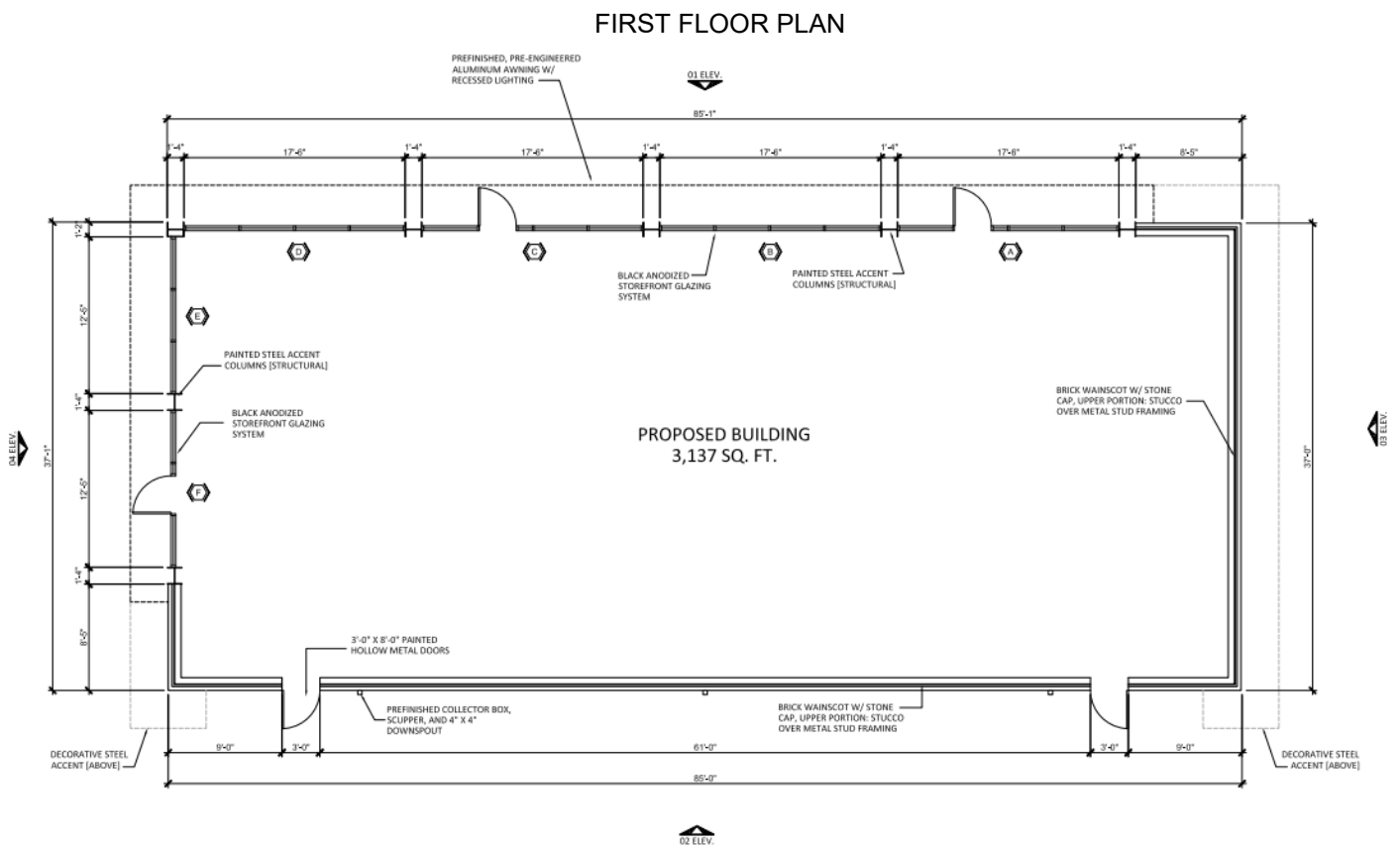
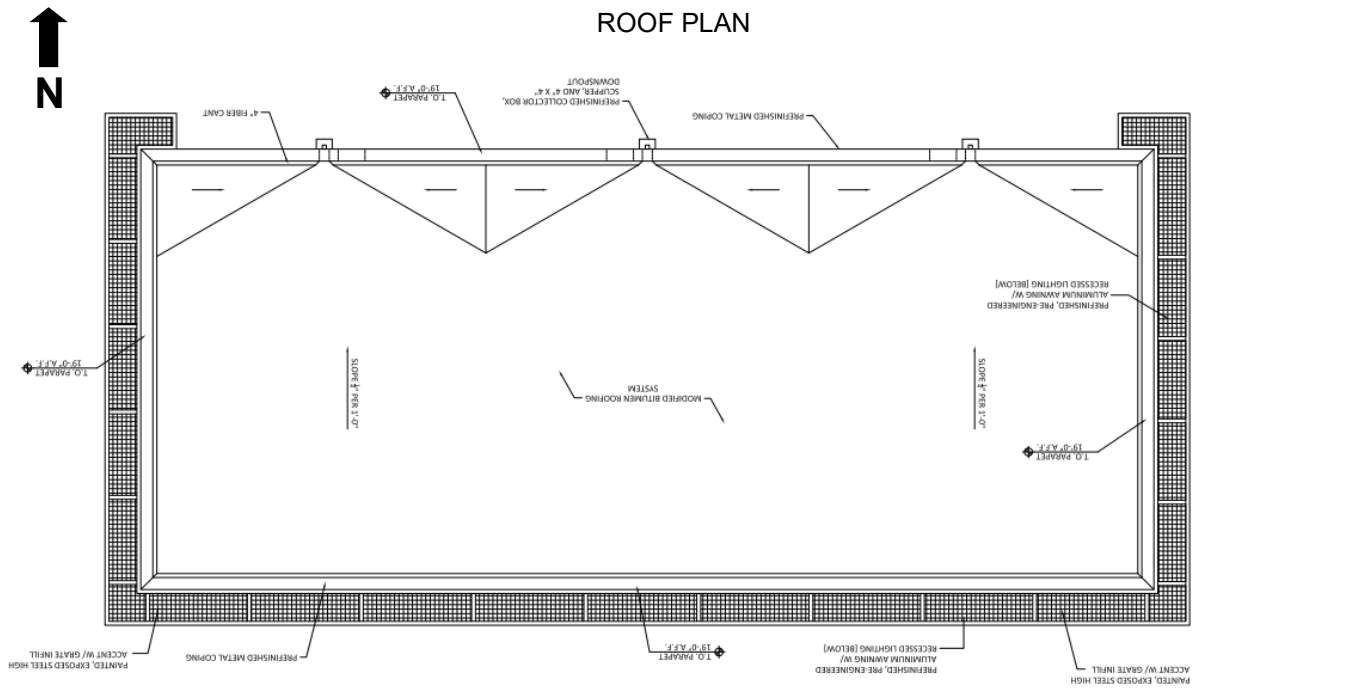

NORTH ELEVATION – FRONT FACING WHITE OAK DRIVE

PROPOSED

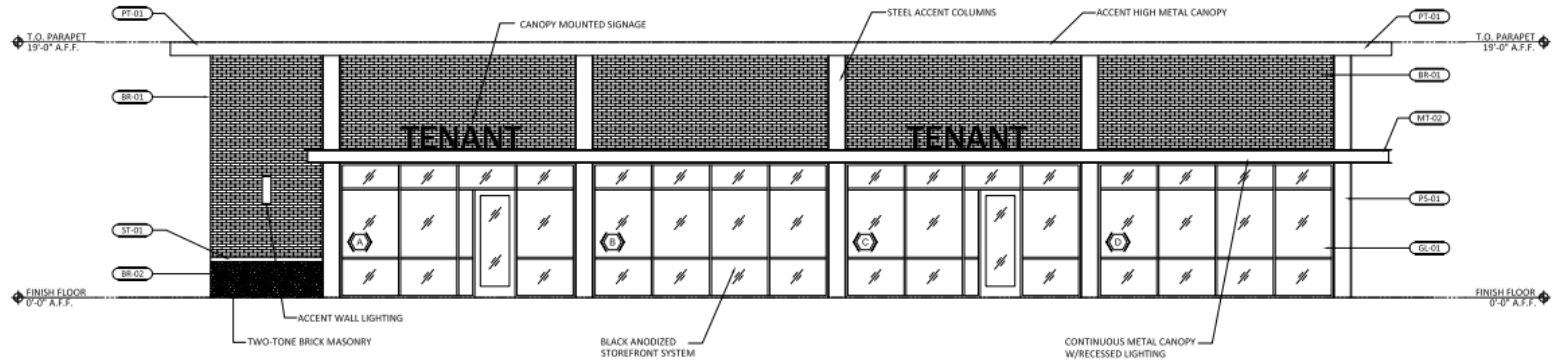

01 NORTH ELEVATION
SCALE: 3/16" = 1'-0"

SOUTH ELEVATION – TOWARDS INTERIOR

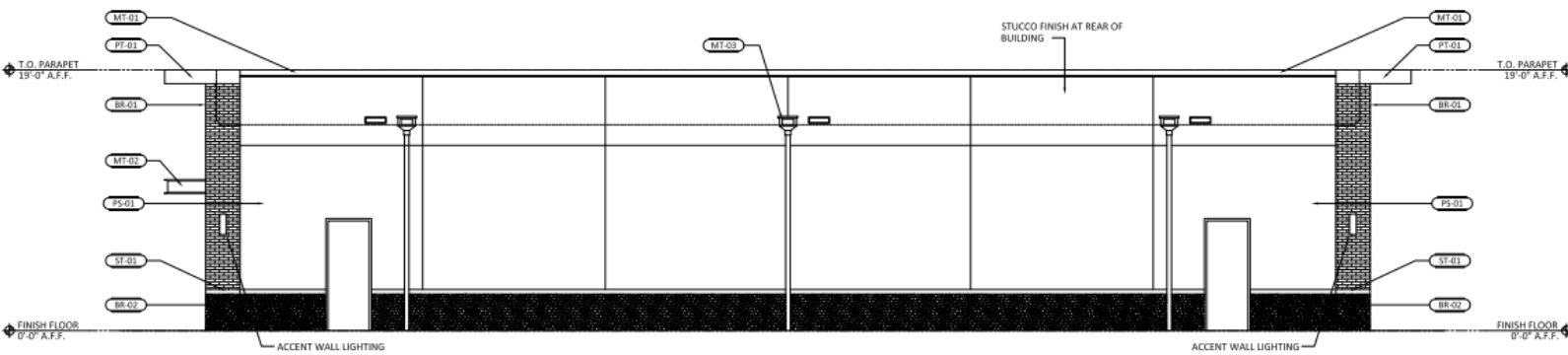

02 SOUTH ELEVATION
SCALE: 3/16" = 1'-0"

EAST ELEVATION – TOWARDS ALLEY

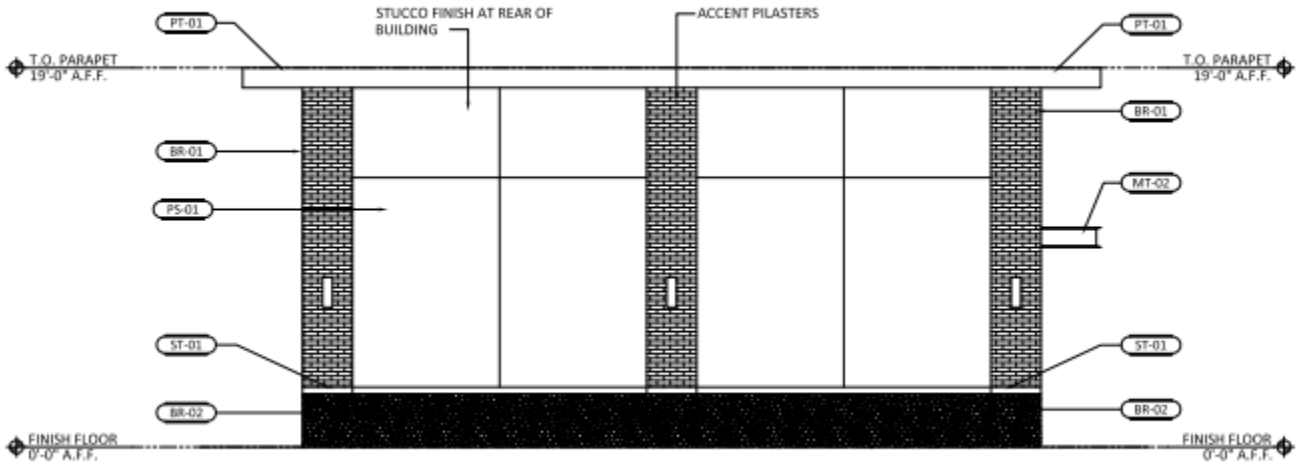

WEST ELEVATION – TOWARDS COLUMBIA STREET

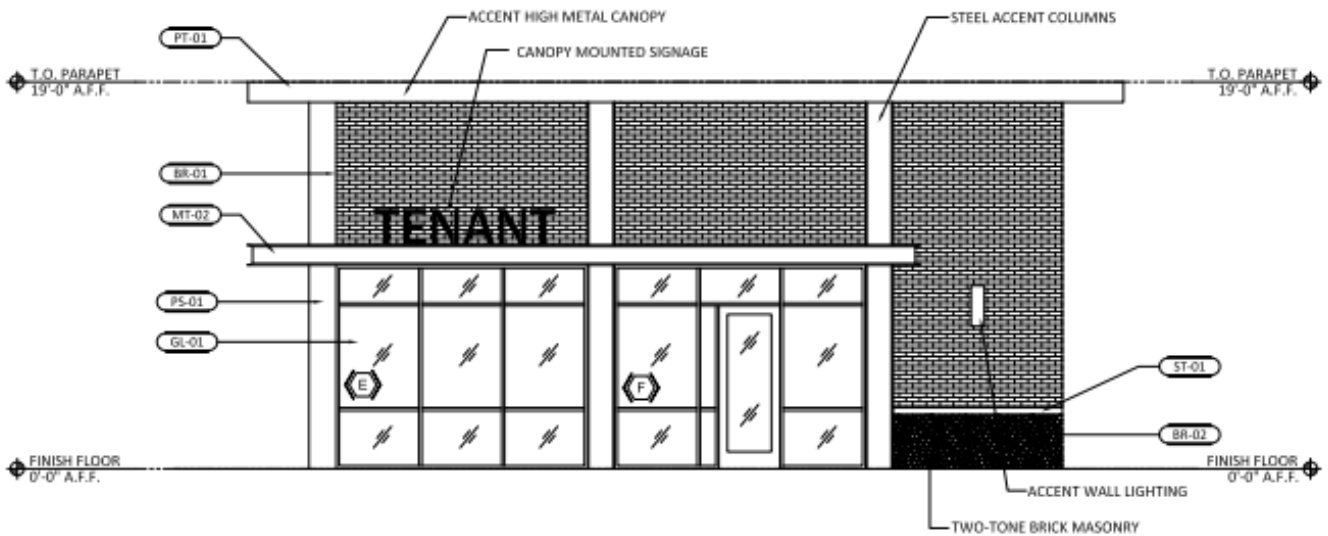

Certificate Of Appropriateness: New Construction Worksheet

(For Houston Heights East, West, or South Districts only)



PLANNING & DEVELOPMENT DEPARTMENT

Please review Houston Heights Design Guidelines for more clarification or larger images - Section 5 - See link here:

https://www.houstontx.gov/planning/HistoricPres/Design_Guide_Heights_District/July2018/Houston-Heights-Design-Guidelines-July2018.pdf

* This form is required. Failure to include accurate and complete requested information below may result in an incomplete application and delay the review/recommendation of the proposed project to Director and HAHC.

Please fill out all information to the best of your knowledge. Not all fields will apply to every project.

Address: 3215 White Oak

Lot Size (Total Sq Ft): 8,257.65 Sq. Ft.

Lot Dimensions (W X L): Non-Rectangular

General New Construction Info:

Primary Building or Accessory Structure ?	Retail Shell	Type of Accessory Building	N/A
Proposed Total Square Footage (including garage and accessory structures)	3,137 Sq. Ft.	Is accessory building conditioned space?	N/A
Total Conditioned Living Space	3,137 Sq. Ft.	Does this new construction include an attached garage?	NO

Historic Preservation Tracker now offers a calculator for Lot Coverage and Floor to Area Ratio (FAR). Please create an application here <https://cohweb.houstontx.gov/HPT/login.aspx> and use that tool to calculate and save a **draft** of your application. We will also accept documents uploaded to Tracker that prove these calculations are accurate. Please refer to Section 5 pages 5-9 and 5-12 in the design guidelines for what must be included or can be exempt from each calculation. https://www.houstontx.gov/planning/HistoricPres/Design_Guide_Heights_District/July2018/Houston-Heights-Design-Guidelines-July2018.pdf

Drawings must be labeled with measurements and support these numbers

Maximum Lot Coverage:

Total Lot Coverage (base sq ft) =	3,137 Sq. Ft.
Total Lot Coverage (% based on lot size) =	38%

Floor to Area Ratio (FAR):

FAR (sq ft) =	3,137 Sq. Ft.
FAR (% based on lot size)* =	0.38

LOT SIZE	MAXIMUM LOT COVERAGE
<4000	.44 (44%)
4000-4999	.44 (44%)
5000-5999	.42 (42%)
6000-6999	.40 (40%)
7000-7999	.38 (38%)
8000+	.38 (38%)

LOT SIZE	MAXIMUM FAR
<4000	.48
4000-4999	.48
5000-5999	.46
6000-6999	.44
7000-7999	.42
8000+	.40

Window information:

Are all windows inset & recessed? YES or NO

Window Notes:
Please upload vendor and material information documents into Preservation Tracker

Black Anodized Aluminum Storefront System, Kawneer Trifab 451 or eq.

Please fill out the window worksheet and review guidelines for drawing submissions

Setbacks:

	Proposed	Shares property line with neighbor -Y/N?
North	5'-0"	N
South	5'-0"	Y
East	33'-0"	N
West	10'-0"	N

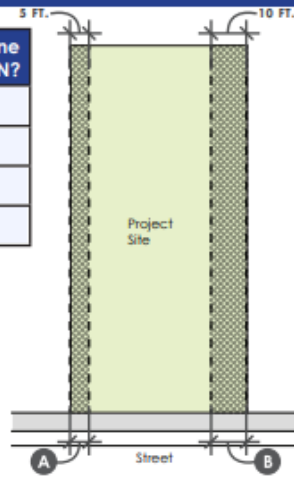

KEY	MEASUREMENT	APPLICATION
A	3 FT.	Minimum distance between side wall and the property line for lots less than 35 feet wide
B	5 FT.	Minimum distance between the side wall and the property line
	REMAINING	Difference between minimum side setback of 5 feet and minimum cumulative side setback
	6 FT.	Minimum cumulative side setback for lots less than 35 feet wide
C	10 FT.	Minimum cumulative side setback for a one-story house
	15 FT.	Minimum cumulative side setback for a two-story house

Note: This diagram shows just one example of a side setback configuration

If new construction is a garage, is it front-facing or alley loading? front-facing alley loading not applicable

Front-facing garage which is located with its rear wall at the alley may have a zero foot setback. An alley-loading garage generally must be located to establish a minimum of 20 feet of clearance from an opposing alley-loading garage door, the rear wall of a front facing garage or a fence (a 24-foot clearance is preferred).

Context Area Setbacks: Are front setbacks within range of contributing buildings for the context area?

(For Primary Buildings only)

YES NO not applicable

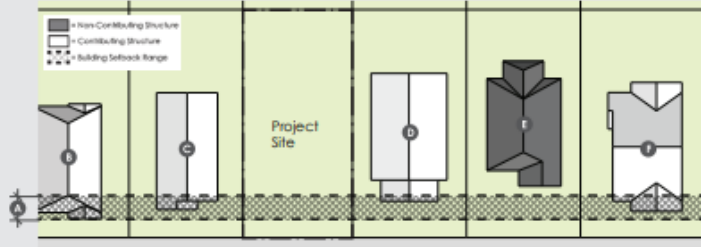

If applicable:	Front Setback of Contributing Neighbors (must be in same historic district)
#1	3320 White Oak - 0'-0"
#2	3400 White Oak - 10'-0"
#3	3301 White Oak - 0'-0"

Max Width/Depth (Overall):

"widest building wall corner to corner"	Proposed
Max Width	40'-0"
Max Depth	N/A
Side wall inset width *if applicable	N/A

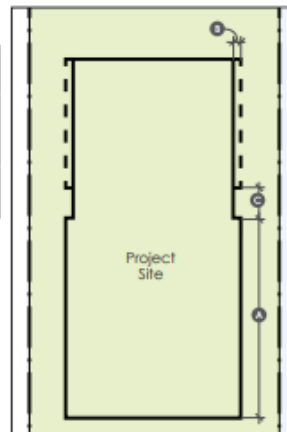

SIDE WALL LENGTH		
KEY	MEASUREMENT	APPLICATION
A	50 FT.	Maximum side wall length without inset (1-story)
	40 FT.	Maximum side wall length without inset (2-story)
	1 FT.	Minimum depth of inset section of side wall (1-story)
B	2 FT.	Minimum depth of inset section of side wall (2-story)
C	6 FT.	Minimum length of inset section of side wall

Front Wall Width/Insets (New Construction of Primary Building only):

Overall building widths are dependent on the width of the lot. The maximum width of a one-story building on a 50-foot-wide lot with a 10 foot minimum cumulative side setback is 40 feet. As a lot gets wider, the building can be wider, to a point; for every two feet of additional lot width the building can be one foot wider. Smaller increases in lot width qualify for the equivalent increase in building width, using a 2:1 ratio; for example, a 60 foot wide lot could have a maximum 50 foot wide building.

widest building wall corner to corner	Proposed
Max Width	88'-0"
Max Depth	3'-3"
Inset Width	

KEY	MEASUREMENT	APPLICATION
A	30 FT.	Maximum front wall width before inset
B	4 FT.	Minimum width of inset section of front wall
C	40 FT.	Maximum width of 1-story building for lots <= 50 ft wide
	35 FT.	Maximum width of 2-story building for lots <= 50 ft wide
	50 FT.	Maximum width of building for lots > 50 ft wide

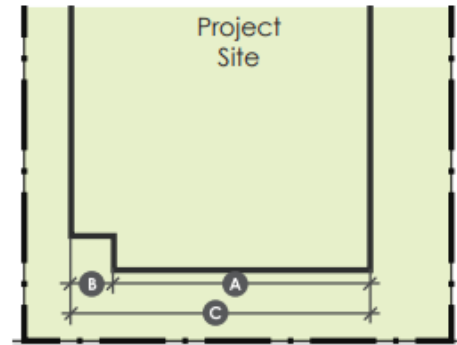

Porch Measurements:

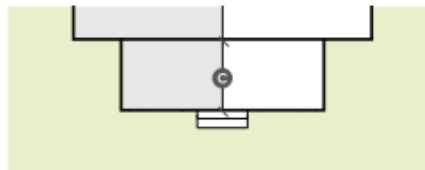
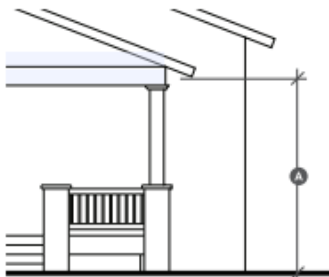

KEY	MEASUREMENT	APPLICATION
C	6 FT.	Minimum depth of front porch

Proposed	Front Porch	Rear Porch
Eave Height	N/A	N/A
Width	N/A	N/A
Depth	N/A	N/A
Railing Height	N/A	N/A
A. % front wall width covered by porch	N/A	N/A

KEY	MEASUREMENT	APPLICATION
A	9-11 FT.	Minimum and maximum 1-story porch eave height.

KEY	MEASUREMENT	APPLICATION
A	50%	Minimum percentage of front wall width that is covered by porch

Example:
 18 ft. Porch Width
 ÷ 26 ft. Width of Front Wall of House
 0.69 (69%) Percentage of Front Wall Covered by Porch

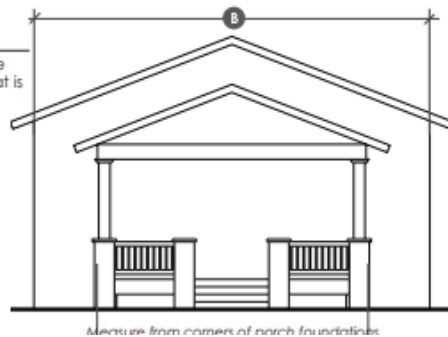

Proposed	Side Porch	Side Porch
Eave Height	N/A	N/A
Width	N/A	N/A
Depth	N/A	N/A
Railing Height	N/A	N/A

Stories, Ridge Height, and Eave Height:

PRIMARY BUILDING 1-STORY EAVE HEIGHT RANGE

PRIMARY BUILDING 2-STORY EAVE HEIGHT RANGE

GARAGE 1-STORY RIDGE HEIGHT

GARAGE 2-STORY RIDGE HEIGHT

KEY	MEASUREMENT	APPLICATION	KEY	MEASUREMENT	APPLICATION
A	12 FT.	Maximum 1-story eave height at the 5 FT. minimum side setback	A	20 FT.	Maximum 2-story eave height at the 5 FT. minimum side setback
B	14 FT.	Maximum 1-story eave height at 7 FT. or greater side setback	B	22 FT.	Maximum 2-story eave height at 7 FT. or greater side setback

Proposed stories	1 STORY
Proposed max ridge height measured from grade	19'-0" [High Parapet]
Proposed max eave height measured from grade	19'-0" [High Parapet]

Building Wall (Plate) Height:

KEY	MEASUREMENT	APPLICATION
A	36 IN.	Maximum finished floor height (as measured at the front of the structure)
B	10 FT.	Maximum first floor plate height
C	9 FT.	Maximum second floor plate height

A. Proposed max finished floor height* measured at front from grade/ground level	0'-0"
B. Proposed first floor height (Plate Height) from max finished floor height	0'-0"
C. Proposed second floor height (Plate Height) from first floor height	N/A

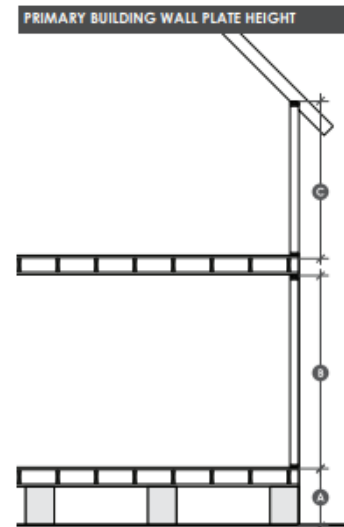

Material Info:

Foundation:

	Proposed
Type	Slab on Grade
Material	Concrete

Do you have flooding issues? YES NO

Roof:

	Proposed
Pitch	1/4" per 1'-0" single slope
Style	Slope with Parapet
Material	Modified Bitumen

Cladding:

	Proposed
Primary Siding Material <small>*If using cementitious siding, smooth is recommended.</small>	Brick/Stone/Stucco
Primary Siding Width Reveal (exposed width)	N/A
Skirting Material	N/A
Soffit Material	Metal Canopies

Porch Details:

	Proposed
Decking Material	N/A
Pier/Base Material	N/A
Column Material	N/A
Step Material	N/A
Railing Material	N/A

Questions or Additional Information:

Single story, retail shell building. Simple structure with exposed structural columns, brick, and glass materials. Metal Canopy Accents and recessed lighting elements at entry points.

PROPOSED WINDOW SCHEDULE

Window	Material	Lite Pattern	Style	Dimensions	Mounting Profile	Brand or Equivalent	Existing To Remain	Other
<i>Ex. A1</i>	<i>Wood</i>	<i>1/1</i>	<i>DH</i>	<i>32 x 66</i>	<i>Recessed</i>	<i>WindowCo.</i>	<i>No</i>	
A	ALUM.	3/4	STRFRNT.	210 x 120	Recessed	Kawneer	N/A	1" INSUL GLASS
B	ALUM.	3/4	STRFRNT.	210 x 120	Recessed	Kawneer	N/A	1" INSUL GLASS
C	ALUM.	3/4	STRFRNT.	210 x 120	Recessed	Kawneer	N/A	1" INSUL GLASS
D	ALUM.	3/4	STRFRNT.	210 x 120	Recessed	Kawneer	N/A	1" INSUL GLASS
E	ALUM.	3/3	STRFRNT.	148 x 120	Recessed	Kawneer	N/A	1" INSUL GLASS
F	ALUM.	3/3	STRFRNT.	148 x 120	Recessed	Kawneer	N/A	1" INSUL GLASS
G	ALUM.	3/3	STRFRNT.	148 x 120	Recessed	Kawneer	N/A	1" INSUL GLASS

Certificate Of Appropriateness:
 Contributing Context Worksheet
 New Construction and Addition



**PLANNING &
 DEVELOPMENT
 DEPARTMENT**

Address: 3215 White Oak Primary Building or Accessory Structure

For New Construction:

Based on Sec. 33-242 of the Historic Preservation ordinance, new construction in a historic district must be **compatible** with exterior features of contributing structures in the context area (same historic district). When designing, elements of existing contributing construction in this district should be referenced, but not necessarily copied. Please give at least three examples of contributing buildings referenced. See this link for new construction criteria:

<https://bit.ly/3xG3NaJ>

Neighboring Contributing Context Address (Reference Address in same historic district)	Number of stories	Ridge Height *If available	Compatibility/Reference Reason Examples: massing, cladding, etc.
3400 White Oak Dr.	1	18'-0" [estimated]	Height, Materials, Massing
3320 White Oak Dr.	1	14'-0" [estimated]	Materials, Massing
810 Harvard	1	28'-0" [estimated]	Materials, Massing, Window Style
Neighboring Context Address * if next door neighbor isn't contributing	Number of stories	Ridge Height *If available	
1051 Heights	2	28'-0" [estimated]	
3601 White Oak	1	17'-0" [estimated]	

For an Addition:

Based on Sec. 33-241 for Alterations, Rehabilitations, Restorations and Additions:

- The proposed alteration or addition must be compatible with the massing, size, scale material and character of the property and the context area; and
- The distance from the property line to the front and side walls, porches, and exterior features of any proposed addition or alteration must be compatible with the distance to the property line of similar elements of existing contributing structures in the context area.

Existing contributing structures must be in the context area (same historic district). Elements of existing contributing construction in this district should be referenced in the design process. Please give at least three examples of these contributing buildings. See this link for alteration criteria:

<https://bit.ly/3wEYfMa>

Neighboring Contributing Context Address (Reference Address in same historic district)	Number of stories	Ridge Height *If available	Compatibility/Reference Reason examples: massing, cladding, etc.
Neighboring Context Address * if next door neighbor isn't contributing	Number of stories	Ridge Height *If available	

01



EXISTING 3400 WHITE OAK, CONTRIBUTING, ESTIMATED HEIGHT 18'-0", MIXED BRICK, CONTINUOUS EXTENDED PARAPET CAP

02



03



EXISTING 3320 WHITE OAK, CONTRIBUTING, ESTIMATED HEIGHT 14'-0", BRICK, WINDOW/STOREFRONT DESIGN, MASSING

04



05



EXISTING 810 HARVARD, CONTRIBUTING, ESTIMATED HEIGHT 28'-0",
BRICK, WINDOW/STOREFRONT DESIGN, MASSING, HEIGHT

06



07



EXISTING 1051 HEIGHTS, CONTRIBUTING, ESTIMATED HEIGHT 28'-0", WINDOW/STOREFRONT DESIGN, MASSING, EXTENDED PARAPET FEATURE

08



09



EXISTING 3601 WHITE OAK, CONTRIBUTING, ESTIMATED HEIGHT 17'-0", CONTINUOUS CANOPY

10



White Oak Drive Corridor References – General contributing context building widths
3401 White oak and 3320 White Oak,

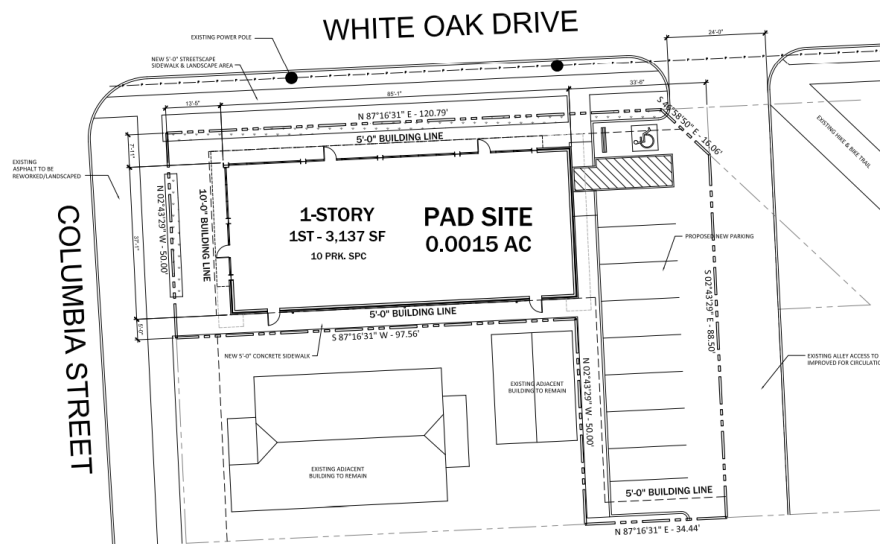
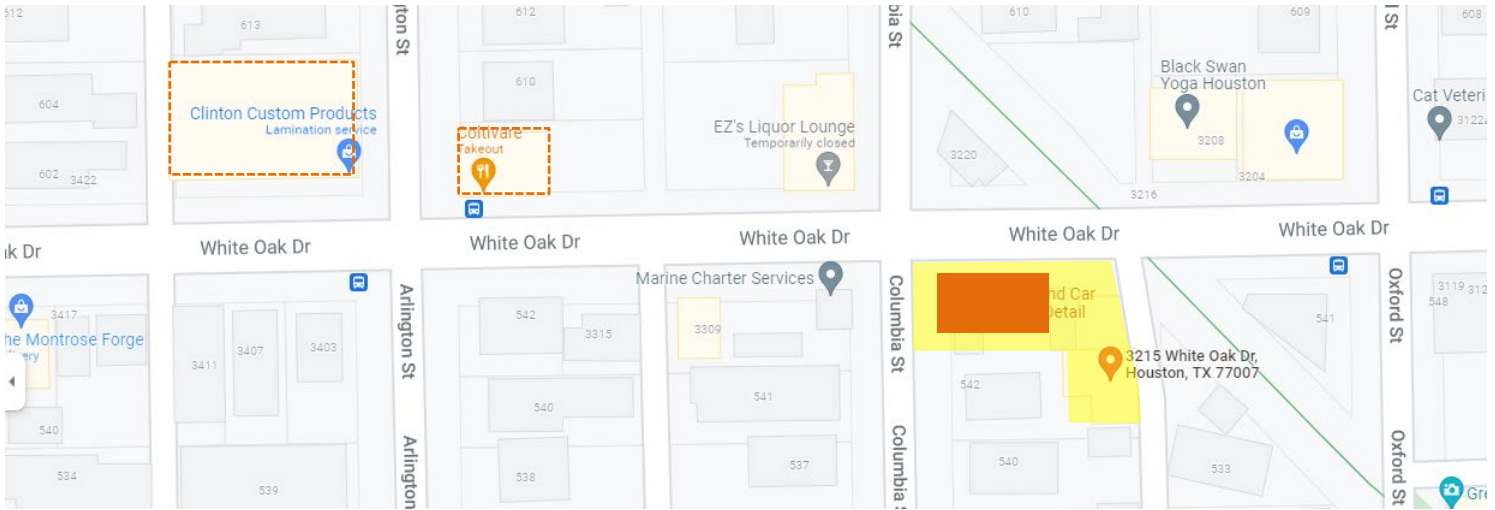

White Oak Drive Corridor References – General contributing context building widths

3601 White Oak – comparable width facing White Oak

